

Data sheet | Item number: 750-628
Bus Extension Coupler Module

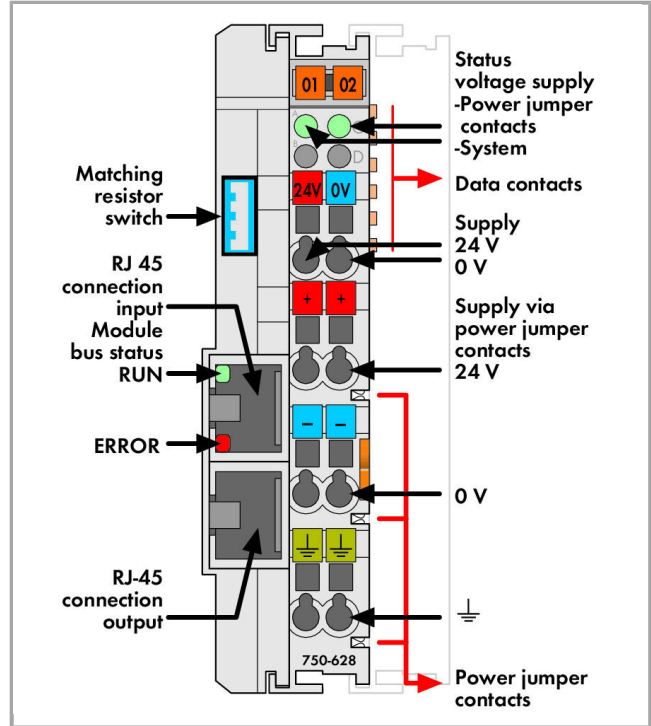

750-628



RoHS Compliant

[BOMcheck.net](https://www.bomcheck.net)

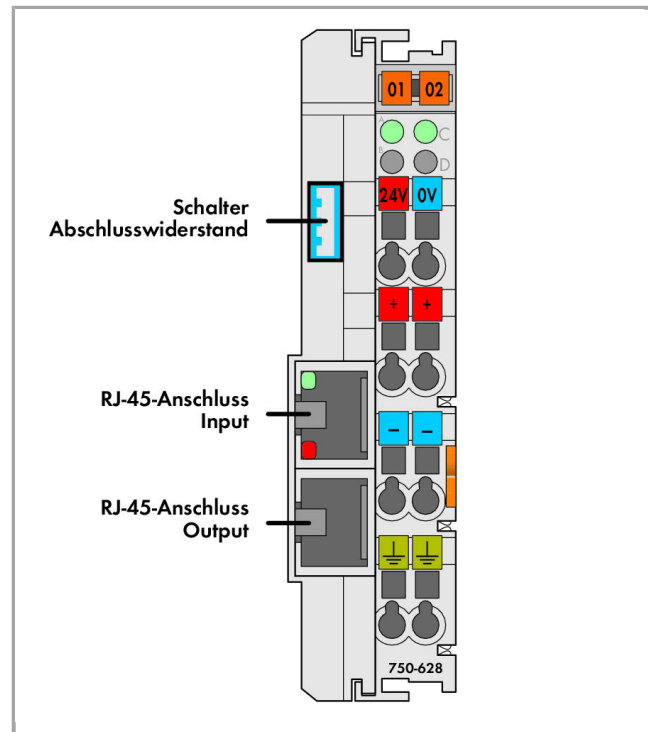
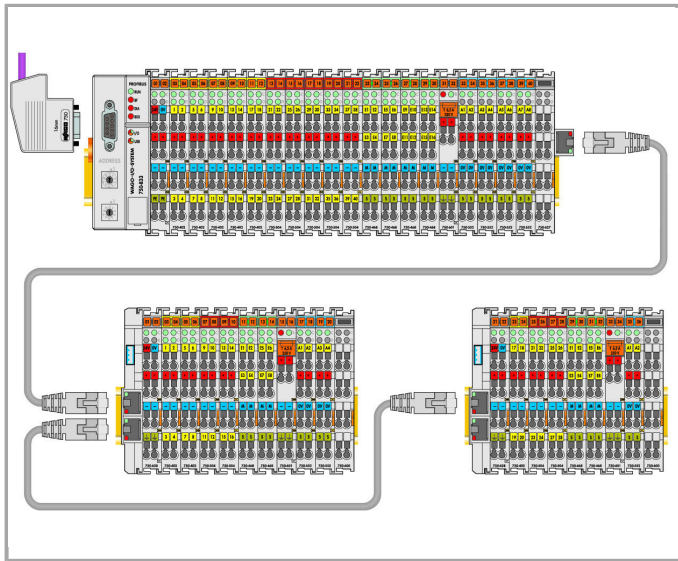

Item description

The coupler module for the internal data bus extension module 750-628 replaces the fieldbus coupler/controller at an I/O terminal block. It is also the mating piece for the end module 750-627. Plug the connecting cable into the top RJ-45 socket to establish the logical link to the fieldbus coupler/controller via end module 750-627. The extension is completely transparent for the fieldbus coupler/controller. All of the functions of the I/O module system are retained without any changes. A further extension to the system is provided by the bottom RJ-45 socket. This enables the entire system to be extended by 10 stages.

The supply voltage for the field side and the internal electronics can be input separately. Both levels are electrically isolated from each other. Two diagnostic LEDs give information about the supply voltage for both the internal and field side. Two LEDs in the input socket indicate fault-free communication with the bus coupler. The extension module can be used as the last coupler module in the system (switch on matching resistor) or as a bridge between two I/O module assemblies.

Installation note Attention:

To ensure safe, reliable operating states when using the internal data bus extension 750-627/-628 these states must be registered prior to startup with the following couplers or PLCs (refer to manual for supported couplers/PLCs). You must use the "WAGO Extension Setting" software for this (download: www.wago.com).

Please note that only one terminating resistor may be activated in the whole system.

Please complete the manufacturing number matrix on the right-hand side of the couplers when updating the firmware and internal operating parameters.

Data

Technical Data

Device-specific

Distance max.: 5 m (10 m see manual), (end module and coupler or coupler and coupler)



Transmission medium	Shielded copper wire (ETHERNET patch cable) 4 x 2 x 0.25 mm ² , twisted pair, double shielding
Number of modules per node max.	64
System supply voltage	DC 24 V(-15 ... +20 %); via wiring level (CAGE CLAMP [®] connection)
Current consumption, system supply (5 V)	150 mA
Total current for system supply	400 mA
System and sensor supply voltage)
Field supply voltage	DC 24 V (-15 ... +20 %); via wiring level (CAGE CLAMP [®] connection)
Input current typ. at rated load (24 V)	200 mA
Efficiency of the power supply (typ.) at nominal load (24 V)	76 %
Isolation	500 V system/supply
Number of outgoing power jumper contacts	3
Current carrying capacity of the power jumper contacts	10 A

Connection data

Connection technology: communication/fieldbus	Local bus: 2 x RJ-45
Connection technology: field supply	6 x CAGE CLAMP [®]
Connection technology: system supply	2 x CAGE CLAMP [®]
Connection type (1)	System/field supply
Solid conductor	0.08 ... 2.5 mm ² / 28 ... 14 AWG
Fine-stranded conductor	0.08 ... 2.5 mm ² / 28 ... 14 AWG
Strip length	8 ... 9 mm / 0.31 ... 0.35 inch

Geometrical Data

Width	24 mm / 0.945 inch
Height	69.8 mm / 2.748 inch
Height from upper-edge of DIN-35 rail	62.6 mm / 2.465 inch
Depth	100 mm / 3.937 inch

Mechanical data

Type of mounting	DIN-35 rail
------------------	-------------

Material Data

Color	light gray
Housing material	Polycarbonate, polyamide 6.6
Weight	73.73 g
Conformity marking	1

Environmental Requirements

Surrounding air (operating) temperature	0 ... 55 °C
Surrounding air (storage) temperature	-40 ... 85 °C
Protection class	IP20
Degree of pollution (5)	2 per IEC 61131-2
Operating altitude	0 ... 2000 m
Mounting position	horizontal (standing/lying) or vertical
Relative air humidity (no condensation)	95 %
Vibration resistance	4g per IEC 60068-2-6
Shock resistance	15g per IEC 60068-2-27
EMC immunity to interference	acc. to EN 61000-6-2, marine applications
EMC emission of interference	acc. to EN 61000-6-4, marine applications
Exposure to pollutants	Per IEC 60068-2-42 and IEC 60068-2-43
Permissible H ₂ S contaminant concentration at a relative humidity 75 %	10 ppm
Permissible SO ₂ contaminant concentration at a relative humidity 75 %	25 ppm

Commercial data

Product Group	15 (Remote I/O)
Country of origin	DE
GTIN	4045454830991
Customs Tariff No.	85389091890

Approvals / Certificates

Country specific Approvals

Logo	Approval	Additional Approval Text	Certificate name
	KC National Radio Research Agency	Article 58-2, Clause 3	MSIP- REM-W43- IDE750

Ship Approvals

Logo	Approval	Additional Approval Text	Certificate name
	BV Bureau Veritas S.A.	-	30389/B0 BV



PRS
Polski Rejestr Statków

-

TE/2216
/880590/18



RINA
RINA Germany GmbH

-









ELE150716XG



















UL-Approvals

















Logo	Approval	Additional Approval Text	Certificate name
	UL UL International Netherlands B.V. (ORDINARY LOCATIONS)	UL 508	E175199 Sec.1













Compatible products

system box

	Item no.: 850-804 IP65 enclosure; Stainless steel; WxHxD (400x123x200 mm); 4 x M20, 16 x M16, 28 x M12 cable grip	850-804
	Item no.: 850-804/000-001 IP65 enclosure; Stainless steel; WxHxD (400x123x200 mm); 2 x M20, 13 x M16, 32 x M12 cable grip	850-804 /000-001
	Item no.: 850-805 IP65 enclosure; Stainless steel; WxHxD (600x123x200 mm); 4 x M20, 19 x M16, 67 x M12 cable grip	850-805
	Item no.: 850-814/002-000 IP65 enclosure; Sheet steel (RAL 7035); WxHxD (200x120x200 mm); without flange plate	850-814 /002-000
	Item no.: 850-815/002-000 IP65 enclosure; Sheet steel (RAL 7035); WxHxD (300x120x200 mm); without flange plate	850-815 /002-000
	Item no.: 850-816/002-000 IP65 enclosure; Sheet steel (RAL 7035); WxHxD (400x120x200 mm); without flange plate	850-816 /002-000
	Item no.: 850-817/002-000 IP65 enclosure; Sheet steel (RAL 7035); WxHxD (600x120x200 mm); without flange plate	850-817 /002-000
	Item no.: 850-825 IP65 enclosure; Aluminium (RAL 7032); WxHxD (160x100x160 mm); 9 x M12, 4 x M20	850-825
	Item no.: 850-826	

	IP65 enclosure; Aluminium (RAL 7032); WxHxD (240x100x160 mm); 4 x M20, 4 x M16, 14 x M12 cable grip		850-826
	Item no.: 850-826/002-000 IP65 enclosure; Aluminium (RAL 7035); WxHxD (240x100x160 mm); 4 x M20, 4 x M16, 14 x M12 cable grip	/002-000	850-826
	Item no.: 850-827 IP65 enclosure; Aluminium (RAL 7032); WxHxD (320x100x160 mm); 4 x M20, 8 x M16, 17 x M12 cable grip		850-827
	Item no.: 850-827/002-000 IP65 enclosure; Aluminium (RAL 7035); WxHxD (320x100x160 mm); 4 x M20, 8 x M16, 17 x M12 cable grip	/002-000	850-827
	Item no.: 850-828 IP65 enclosure; Aluminium (RAL 7032); WxHxD (480x100x160 mm); 4 x M20, 10 x M16, 35 x M12 cable grip		850-828
	Item no.: 850-828/002-000 IP65 enclosure; Aluminium (RAL 7035); WxHxD (480x100x160 mm); 4 x M20, 10 x M16, 35 x M12 cable grip	/002-000	850-828
	Item no.: 850-834 IP65 enclosure; Polyester (RAL 7032); WxHxD (164x100x164 mm); 9 x M12, 4 x M20		850-834
	Item no.: 850-835 IP65 enclosure; Polyester (RAL 7032); WxHxD (244x100x164 mm); 4 x M20, 4 x M16, 14 x M12 cable grip		850-835
	Item no.: 850-836 IP65 enclosure; Polyester (RAL 7032); WxHxD (324x100x164 mm); 4 x M20, 8 x M16, 17 x M12 cable grip		850-836
Carrier rail			
	Item no.: 210-112 Steel carrier rail; 35 x 7.5 mm; 1 mm thick; 2 m long; slotted; according to EN 60715; "Hole width 25 mm		210-112
	Item no.: 210-113 Steel carrier rail; 35 x 7.5 mm; 1 mm thick; 2 m long; unslotted; according to EN 60715		210-113
	Item no.: 210-114 Steel carrier rail; 35 x 15 mm; 1.5 mm thick; 2 m long; unslotted; similar to EN 60715		210-114
	Item no.: 210-115 Steel carrier rail; 35 x 7.5 mm; 1 mm thick; 2 m long; slotted; according to EN 60715; "Hole width 18 mm		210-115
	Item no.: 210-118 Steel carrier rail; 35 x 15 mm; 2.3 mm thick; 2 m long; unslotted; according to EN 60715		210-118
	Item no.: 210-196 Aluminum carrier rail; 35 x 8.2 mm; 1.6 mm thick; 2 m long; unslotted; similar to EN 60715		210-196
	Item no.: 210-197 Steel carrier rail; 35 x 15 mm; 1.5 mm thick; 2 m long; slotted; similar to EN 60715		210-197
	Item no.: 210-198 Copper carrier rail; 35 x 15 mm; 2.3 mm thick; 2 m long; unslotted; according to EN 60715		210-198
	Item no.: 210-504 Steel carrier rail; 35 x 7.5 mm; 1 mm thick; 2 m long; slotted; galvanized; according to EN 60715		210-504

	Item no.: 210-505 Steel carrier rail; 35 x 7.5 mm; 1 mm thick; 2 m long; unslotted; galvanized; according to EN 60715	210-505
	Item no.: 210-506 Steel carrier rail; 35 x 15 mm; 1.5 mm thick; 2 m long; unslotted; galvanized; similar to EN 60715	210-506
	Item no.: 210-508 Steel carrier rail; 35 x 15 mm; 1.5 mm thick; 2 m long; slotted; galvanized; similar to EN 60715	210-508
shield connection		
	Item no.: 790-108 Shield clamping saddle; 11 mm wide; diameter of compatible conductor	790-108
	Item no.: 790-116 Shield clamping saddle; 19 mm wide; diameter of compatible conductor; 7 ... 16 mm	790-116
	Item no.: 790-124 Shield clamping saddle; 27 mm wide; diameter of compatible conductor; 6 ... 24 mm	790-124
	Item no.: 790-140 Shield clamping saddle; diameter of compatible conductor	790-140
	Item no.: 790-208 Shield clamping saddle; 12.4 mm wide; 3 ... 8 mm	790-208
	Item no.: 790-216 Shield clamping saddle; 21.8 mm wide; 6 ... 16 mm	790-216
	Item no.: 790-220 Shield clamping saddle; 30 mm wide; 6 ... 20 mm	790-220
Marking accessories		
	Item no.: 2009-145 Mini-WSB Inline; for Smart Printer; on reel; stretchable 5 - 5.2 mm; plain; snap-on type	2009-145
	Item no.: 2009-145/000-002 Mini-WSB Inline; for Smart Printer; on reel; stretchable 5 - 5.2 mm; plain; snap-on type	2009-145 /000-002
	Item no.: 2009-145/000-005 Mini-WSB Inline; for Smart Printer; on reel; stretchable 5 - 5.2 mm; plain; snap-on type	2009-145 /000-005
	Item no.: 2009-145/000-006 Mini-WSB Inline; for Smart Printer; on reel; stretchable 5 - 5.2 mm; plain; snap-on type	2009-145 /000-006
	Item no.: 2009-145/000-007 Mini-WSB Inline; for Smart Printer; on reel; stretchable 5 - 5.2 mm; plain; snap-on type	2009-145 /000-007
	Item no.: 2009-145/000-012 Mini-WSB Inline; for Smart Printer; on reel; stretchable 5 - 5.2 mm; plain; snap-on type	2009-145 /000-012
	Item no.: 2009-145/000-023 Mini-WSB Inline; for smartPRINTER; on reel; stretchable 5 - 5.2 mm; plain; snap-on type	2009-145 /000-023

	Item no.: 2009-145/000-024 Mini-WSB Inline; for Smart Printer; on reel; stretchable 5 - 5.2 mm; plain; snap-on type	2009-145 /000-024
	Item no.: 248-501 Miniature WSB Quick marking system; plain; Marker width 5 mm; 10 strips with 10 markers per card	248-501
	Item no.: 248-501/000-002 Mini-WSB marking card; as card; not stretchable; plain; snap-on type	248-501 /000-002
	Item no.: 248-501/000-005 Mini-WSB marking card; as card; not stretchable; plain; snap-on type	248-501 /000-005
	Item no.: 248-501/000-006 Mini-WSB marking card; as card; not stretchable; plain; snap-on type	248-501 /000-006
	Item no.: 248-501/000-007 Mini-WSB marking card; as card; not stretchable; plain; snap-on type	248-501 /000-007
	Item no.: 248-501/000-012 Mini-WSB marking card; as card; not stretchable; plain; snap-on type	248-501 /000-012
	Item no.: 248-501/000-017 Mini-WSB marking card; as card; not stretchable; plain; snap-on type	248-501 /000-017
	Item no.: 248-501/000-023 Mini-WSB marking card; as card; not stretchable; plain; snap-on type	248-501 /000-023
	Item no.: 248-501/000-024 Mini-WSB marking card; as card; not stretchable; plain; snap-on type	248-501 /000-024
	Item no.: 750-100 Marker card; as a DIN A4 sheet; plain	750-100
	Item no.: 750-103 Group marker carrier	750-103
	Item no.: 750-106 Group marker carrier	750-106

Downloads

Documentation

Manual

Internal Data Bus Extension Coupler module	V 1.2.0	pdf 2.3 MB	Download
---	---------	---------------	----------

**Bid Text**

750-628 IO-Klemmen	Apr 4, 2012	doc 29.7 kB	Download
-----------------------	-------------	----------------	----------

Additional Information

Disposal; Electrical and electronic equipment, Packaging	V 1.0.0	pdf 265.8 kB	Download
--	---------	-----------------	----------

System Description

750/753 Series I/O-System – General Product Information		pdf 1.7 MB	Download
Use in Hazardous Environments Term definition, marking and installation regulations	V 1.0.0	pdf 1.0 MB	Download
Design Notes Basic conditions and recommendations for higher operational safety	V 2.0.0	pdf 1.5 MB	Download
Overview on WAGO-I/O-SYSTEM 750 approvals		pdf 780.2 kB	Download

CAD/CAE - Smart Data**CAD data**

3D Download 750-628		URL	Download
---------------------	--	-----	----------

Device Files**Device Driver**

WAGO USB Service Cable Driver / 750 and 857 Series 759-923	6.5.3.0 Sep 10, 2014	zip 4.8 MB	Download
---	-------------------------	---------------	----------

Product family

750/753 Series I/O-System
[Learn more about the product family.](#)

[Show all products from the family](#)



Subject to changes.
